

marcy.



Instructions for use.

marcy. The anterior-walker for more independence and mobility



Our promise.



Dear Customer,

at this point we would like to thank you for placing your trust in our company and for purchasing our product. We ask you to read through the Instructions for use carefully prior to initial commissioning of the product, and to observe them. Please note that guidelines and representations in these Instructions for use may deviate from your product due to differing equipment.

We reserve the right to make technical modifications.

Important information!

Ensure that these Instructions for use remain with the product..

Your **schuchmann**-Team



1. Preparation.	05
1.1 Delivery	05
1.2 Safety measures prior to use	05
1.3 Safe disposal	05
1.3.1 Packaging	05
1.3.2 Product	05
1.4 Where to store the Instructions for use	05
2. Product description.	06
2.1 Material information	06
2.2 Handling / Transport	06
2.3 Application areas, use according to the intended purpose	06
2.4 Use not in accordance with the intended purpose / warning guidelines	07
2.5 Equipment for basic model	07
2.6 Auflistung Zubehör	08
2.7 Product overview	08
3. Anwendungshinweise.	09
3. Anwendungshinweise	09
3.1 Nutzung	09
4. Settings.	10
4.1 Handles	10
4.1.1 Handle height adjustment	10
4.1.2 Setting the handles width	10
4.2 Direction locks (optional)	11
4.3 Friction brake (optional)	11
4.4 Parking brake (optional)	11
4.5 Bench (optional)	12
4.6 Storage basket (optional)	12
4.7 Lower armrests (optional)	13
4.8 Handle/grip ball for lower armrests	13
4.9 Folding the frame up/down	14
4.10 Backwards stop (optional)	14
4.11 Teleskopierbarer Radstand (optional)	14
5. Repairs and cleaning.	15
5.1 Cleaning	15
5.2 Repairs	15
5.3 Ersatzteile	15
5.4 Duration of use and re-use	15
6. Technical data.	16
7. Identification.	18
7.1 EC declaration of conformity	18
7.2 Serial number / date of manufacture	19
7.3 Product version	19
7.4 Issue of the document	19
7.5 Name and address of the manufacturer, specialist dealer supplying the product	19

1. Preparation.

1.1 Delivery

On receiving the product, please check it for completeness, lack of faults and check it for any transport damage. Inspect the goods in the presence of your forwarder. Should transport damage have occurred, please arrange for an inventory (determination of the faults) to be made in the presence of the forwarder. Please send a complaint in writing to the specialist dealer responsible.

1.2 Safety measures prior to use

Correct usage of the anterior walker requires precise and careful training of the accompanying person. We ask you to read through the Instructions for use carefully prior to initial commissioning of the upright trainer, and to observe them. Cushioned parts may become warm when exposed to direct sunlight. Cover these parts or protect the equipment from direct sunlight.

1.3 Safe disposal

In order to preserve and protect the environment, to prevent environmental pollution, and to improve the recycling of raw materials, please note the disposal instructions in **points 1.3.1** and **1.3.2**.

1.3.1 Packaging

The product packaging should be stored in case the product needs to be transported again. Should you have to return the product for repairs or in case of a guarantee claim, please if possible use the original box so that the product is optimally packaged. Separate the packaging materials for recycling according to their classification. Do not leave packaging materials unattended, as they are a possible source of danger.

1.3.2 Product

Separate the raw materials used in the product for recycling according to their classification (see material information under **2.1**).

1.4 Where to store the Instructions for use

Please store these Instructions for use carefully and ensure that these Instructions for use remain with the product in case of re-use.



2. Product description.

2.1 Material information

The base frame and the individual elements are made of aluminium which is noncorroding and powder-coated. The lower arm rests are made of PU and the bench is padded and covered. The cover is made of 100% polyester and are flame resistant (according to DIN EN 1021-1+2).

2.2 Handling / Transport

The posterior walker is not designed to be carried, as it is fitted with wheels. Should you have to carry the equipment due to obstacles, ensure that all moving parts are tightened. Stand next to the posterior walker, hold on to the left and right handles and lift it over the obstacle. To transport the posterior walker, fold the frame (see **point 3.9**).

The frame of the marcy. size 0 + 1 cannot be folded! In this case, set everything at its most compact (fold up bench, set handles to lowest setting etc.) Lift the compact unit by stepping between the frame from the rear and then holding on to it on the left and right.

2.3 Application areas, use according to the intended purpose

Indications

The anterior-walker **marcy.** has been designed for children and teenagers who receive too much support from a posterior-walker but would not manage a standard anterior-walker. The user's torso must provide more stabilisation when using an anterior-walker in comparison to a posterior-walker.

marcy. offers the opportunity to adjust the wheel base and therefore increase the support area to the back. This is how the patient's body centre of gravity shifts within the support area of the anterior-walker. When walking with **marcy.**, the muscle tension in the arms and legs increases and precisely this increased strain represents an important indication for an anteriorwalker seen from a medical-therapeutic point of view.

2. Product description.

Contraindications

In general, the indications for walking training should be approved by a doctor or orthopedist. It should therefore be clarified prior to procurement whether contraindications exist for the user. In general, any type of pain represents a contraindication. Walking training should not be provided without establishing prior to use whether the user has an abnormal foot position, which requires medical attention.



2.4 Use not in accordance with the intended purpose / warning guidelines

- Correct usage of the product requires precise and careful training of the accompanying person.
- The product may not be used without supervision.
- The anterior-walker may only be used indoors on a solid, even ground.
- The max. height adjustment is specified by a marking – no settings may be made beyond this range.
- Please observe point 5 „Technical data“ in these instructions for use for the maximum permitted patient weight.
- After all adjustments, firmly re-tighten the screw connections you have loosened!
- Hanging on heavy bags or other items can negatively influence the stability.
- Only use accessories and spare parts made by Schuchmann, otherwise you will endanger the child.
- Please ensure that none of the user's extremities are in the respective area when making adjustments to avoid the risk of injury.
- Users who have difficulty reading must have someone read these Instructions for use aloud so that they understand how to use the product.

2.5 Equipment for basic model

- Light and folding aluminium frame (Size 2+3 folds down)
- Individually height and width adjustable handles
- PU tyres (150 mm for Size 0+1, 200 mm for Size 2+3)



2. Product description.

2.6 Auflistung Zubehör

- Lower armrests with handles
- Lower armrests with grip balls
- Bench
- Parking handbrake
- Friction brake
- Storage basket
- Direction locks
- Telescopic wheelbase

2.7 Product overview

The Fig. below is intended to show you the designation of the most important components as well as the terms which you will find in these Instructions for use.

Handles

Seat

Direction locks (optional) for the guide wheels

Storage basket

Light aluminium frame (Size 2 +3 folds down)

PU tyres



3. Anwendungshinweise.

3. Instructions for use

Prior to using the anterior walker, it may be necessary to open up the frame (for sizes 2-3). Apply the locking device and/or the friction brake so that the walker cannot roll away. Adapt **marcy.** to the dimensions of the user by adjusting the height and width of the handles so that the user's elbows are slightly bent. If available, adjust the forearm supports in depth, height, angle and tilt to the respective elbow height. Prior to use, release the parking brake and/or the friction brake.

3.1 Use

To use the anterior walker, the child/adolescent grips the handles tightly. If applicable, release the parking handbrake and/or the friction brake. By pushing **marcy.** forward, enough space is made to allow the user to take their first step. Both sides are pushed evenly when walking straight ahead. By steering (pushing just one side, pulling of the other), you can walk around bends and avoid obstacles. In case of fatigue, the user can use the seat to take a break if available. If available, the brakes must be used on slopes. In case of hills, ensure that **marcy.** does not roll backwards. On stopping, the parking brakes must be applied. When using **marcy.** the user must always be extremely careful. If **marcy.** does not offer a sufficiently large support surface, the wheelbase must be adapted. The backwards stop is to be used to prevent inadvertent rolling away, if available. If it is necessary to encourage walking straight ahead, simply activate the directional locking devices if available. To control the speed, use the optional friction brake



4. Settings.

Settings and adjustments to the product or accessories may only be made by people who have been given the necessary instructions by a medical product advisor. Please ensure that none of the user's extremities are in the respective area when making adjustments to avoid the risk of injury.

4.1 Handles

The handles can be individually be adjusted in height and width for adjustment to individual body size.

4.1.1 Handle height adjustment

To adjust the height, please loosen the star handles (A), bring the handles into the required position and then re-tighten the star handles. A gauge (B) permits precise height adjustment of the handles. Make sure that the handle is not pulled out of the handle mount beyond the STOP marking (C) as sufficient clamping can no longer be guaranteed in this case. The height can also be changed by using the width adjustment (see 4.1.2)

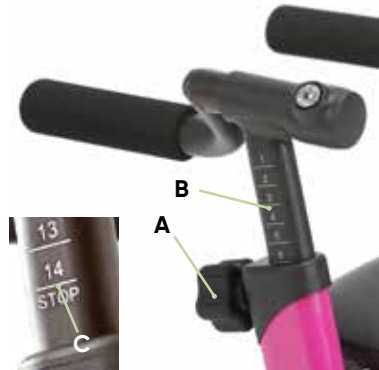

The handles may not be pulled out of the handle mount beyond the STOP mark!

4.1.2 Setting the handles width

To adjust the width, please loosen the cylinder head screw with inner hexagon (D), bring the handles into the required position and then retighten the cylinder head screw with inner hexagon. As previously mentioned in point 3.1.1, the handle height can also be changed by adjusting the width (E).

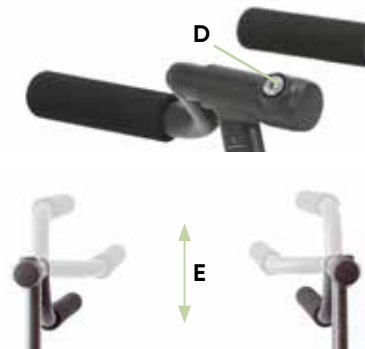

After each adjustment, please re-tighten all screw connections!

4. Settings.

4.2 Direction locks (optional)

It is possible to drive straight on by locking the guide wheels. To release the guide wheels lock, pull the direction lock (A) gently upwards and turn it a quarter turn to the left or right. The guide wheels can now move freely and allow independent steering. Pull the direction lock (A) gently upwards and turn it a quarter turn to the left or right again to apply the guide wheels lock. The direction locks click back in as soon as the guide wheels are aligned straight.



4.3 Friction brake (optional)

The function of the friction brake is to slowly reduce the speed of the rear wheel rollover. By turning screw (B) (loosen lock nut (C) beforehand) in and out, the pressure the friction brake has on the wheel can be changed and therefore the wheel rolling speed.

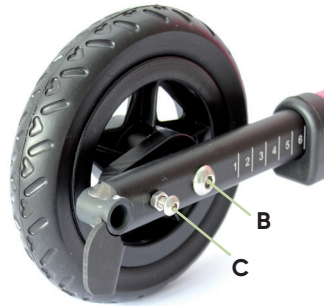

After each adjustment, please retighten the lock nut

4.4 Parking brake (optional)

Against unintentionally rolling away and for a secure footing the posterior walker can be equipped with a parking handbrake. Please pull the brake lever (D) and lock into the red catch (E). To release, please pull the lever again (D) and pull at the same time the red pawls (E).

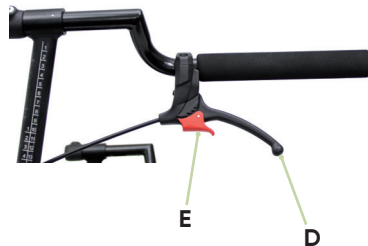

4. Settings.

4.5 Bench (optional)

The bench is padded and covered. It is permanently mounted to the frame and includes a back strap.



4.6 Storage basket (optional)

The storage basket is permanently mounted to the frame and offers space for toys, drinks or similar items.



The maximum loading of the storage basket for size 0 + 1 of 8 kg must not be exceeded!



The maximum loading of the storage basket for size 2 + 3 of 5 kg must not be exceeded!



4. Settings.

4.7 Lower armrests (optional)

The lower armrests can be equipped with a handle or grip ball. They can be adjusted in depth, height, angle and inclination.

Depth adjustment

Loosen the cylinder head screw with inner hexagon (A) beneath the lower armrest. Now you can slide it onto the pipe (B) and bring it into the required position.

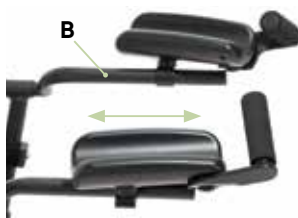

Note the setting mark on the tube (B).

Height adjustment

The handles are used to set the height (see **points 3.1.1 + 3.1.2**).

Adjustment of the angle

The angle (C) is set using a locking hinge. Loosen the cylinder head screw with inner hexagon (A) beneath the lower armrest and bring the lower armrest into the required position.



Angle adjustment

Loosen the cylinder head screw with inner hexagon (A) beneath the lower armrest to set the inclination (D) and bring the lower armrest into the required position.



4.8 Handle/grip ball for lower armrests

Please loosen the hexagon socket screws (E) and bring the handle (F) or grip ball (G) into the required position.



After each adjustment, please re-tighten all screw connections!



4. Settings.

4.9 Folding the frame up/down

Frame sizes 2 + 3 can be folded for easy transportation or better storage of the anterior-walker. Pull both locking bolts (A) at the same time and fold the frame up (B). Simply pull the frame apart to unfold. Make sure that the locking bolts click back in.



Only the frames of the marcy. size 2 + 3 can be folded!



Locking bolts must click back in again after unfolding.



4.10 Backwards stop (optional)

In order to prevent unintentional rolling back, **marcy.** can be optionally equipped with the backwards stop. The backwards locks are integrated in the rear wheels and can be activated or deactivated depending on the situation.

Activating the backwards stop

Turn the locking bar (C) by a half turn upwards and move the wheel backwards until the locking bar (A) audibly clicks in.

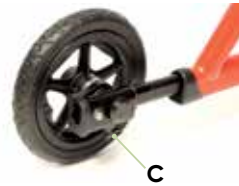

Deactivating the backwards stop

Turn the locking bar (C) a half turn downwards until it is held in place by the catch.

4.11 Telescopic wheelbase (optional)

marcy. offers the opportunity to adjust the wheelbase and therefore increase the support area to the back. This is how the patient's body centre of gravity shifts within the support area of the anterior-walker. In order to extend the wheelbase, undo the screw (D) underneath the frame. Now pull out the wheelbase to the required position and fix the screw again. The wheelbase may not be pulled out of the adapter over the STOP marking (E)!

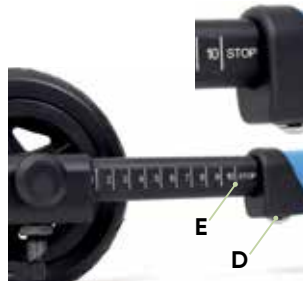

The wheelbase may not be pulled out of the adapter over the STOP marking (E)!

5. Repairs and cleaning.

5.1 Cleaning

All frame elements and surfaces can be cleaned with a sponge or moist cloth using normal antibacterial detergents. The covers can be removed and washed at 30° in the washing machine. Please also pay attention to our general cleaning and hygiene advice. You can find them at www.schuchmann.de/marcy.



Do not use aggressive cleaning agents, eg. solvent, as well as hard brushes etc.

5.2 Repairs

Please carry out a daily visual inspection and check the anterior walker regularly for cracks, breaks, missing parts and malfunctions. In case of a defect or malfunction, please contact the specialist dealer who supplied you with the product (see **8.5**).

5.3 Ersatzteile

Should you wish to order spare parts, please contact the specialist dealer who supplied you with the upright trainer, stating the serial number of the upright trainer (see **8.5**). Necessary spare parts and accessories must only be installed by trained personnel.

5.4 Duration of use and re-use

The expected duration of use of our product, dependent on the usage intensity and amount of re-use, totals up to „8“ years, if the usage takes place in accordance with the information in these Instructions for use. It may be possible to use the product over and above this time period if it is in a safe condition. The expected duration of use does not refer to wear parts, such as for example covers, wheels The maintenance and evaluation of the condition, and if applicable the potential for re-use, must be decided by the specialist trader. The upright trainer is suitable for re-use. Prior to forwarding on, please follow the cleaning and disinfection instructions in **Chapter 5**. Accompanying documents such as these instructions for use are part of the product, and must be transferred to the new user. Accompanying documents such as these Instructions for use are part of the product and must be passed on to the new user. No disassembly is required prior to re-use. In the case of storage, it is recommended to fold the product frame (see **point 4.9**) to the smallest dimension to save space.



6. Technical data.

Dimensions - basic model

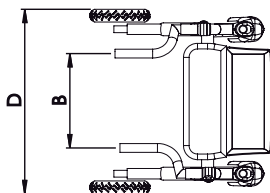
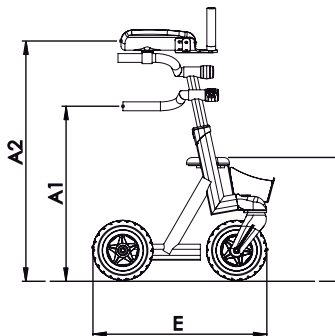

		Size 0	Size 1	Size 2	Size 3
A1	Handle height	30 - 47 cm	38 - 59 cm	53 - 75 cm	63 - 88 cm
A2	Height of lower armrests	41 - 58 cm	49 - 70 cm	63 - 85 cm	73 - 98 cm
B	Handle spacing	18 - 32 cm	22 - 36 cm	30 - 44 cm	36 - 50 cm
C	Seat height	25 cm	30 cm	45 cm	45 cm
D	Total width	44 cm	48 cm	62 cm	71 cm
E	Total length	36,5 cm	42,5 cm	57,5 cm	61 cm
E	Total length (telescopic wheelbase)	39 - 47 cm	45 - 55 cm	60 - 74 cm	65 - 79 cm
	Max. load	20 kg	30 kg	50 kg	65 kg
	Weight	4,2 kg	5 kg	7,4 kg	9,1 kg

6. Guarantee.

The two-year statutory guarantee period shall apply for all products. This guarantee period shall begin with the delivery or handover of the goods. Should a verifiable material or manufacturing fault occur within this time period, we shall, after carriage paid return to us, view the indicated damage and, if applicable, either repair or deliver a new product at our discretion.



7. Identification.

7.1 EC declaration of conformity

Company Schuchmann GmbH & Co.KG
 Dütestr. 3
 D-49205 Hasbergen
 Tel.: +49 (0) 54 05 / 909 - 0
 Fax: +49 (0) 54 05 / 909 - 109



declares on their sole responsibility that the product named below is classified as product class 1

marcy. The anterior-walker for more independence and mobility

Art.-Nr.: 76 00 000 (Size. 0)	76 00 100 (Size 0 - telescopic)
76 01 000 (Size 1)	76 01 100 (Size 1 - telescopic)
76 02 000 (Size 2)	76 02 100 (Size 2 - telescopic)
76 03 000 (Size 3)	76 03 100 (Size 3 - telescopic)

The relevant regulations of the regulations and guidelines listed below accord with:

- EC Directive 93/42/EEC on medical products from 14th June 1993
- DIN EN 12182:1999 Technical aids for the disabled
- EN ISO 14971 Medical products - Application of risk management on medical products
- DIN EN ISO 11199-3:2005 Walking aids manipulated by both arms - Requirements and test methods - Part 3: Walking tables

This declaration of conformity applies only for products with the article numbers stated above and is valid until 31.12.2019.

Date 28.07.2014

Signature

Name Torsten Schuchmann

Role Safety Representative for Medical Products

7. Identification.

7.2 Serial number / date of manufacture

The serial number, the date of manufacture and other information can be found on the type plate, which is located on all of our products (A).

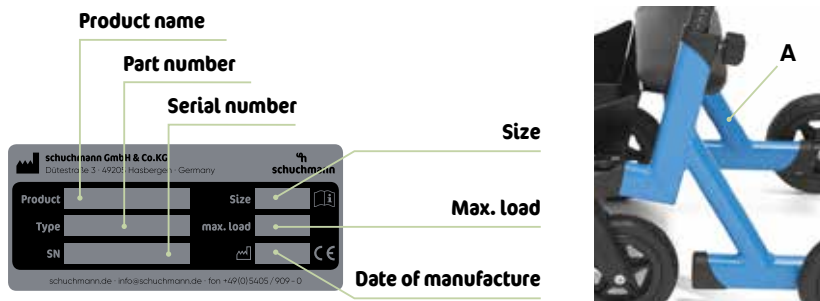

7.3 Product version

The **marcy**. anterior-walker is available in four sizes and can be supplemented through a diverse range of accessories (see **point 2.5**). Each size is also available as a telescopic version.

7.4 Issue of the document

Instructions for use **marcy**. – Change status G; Issue 09.2018

7.5 Name and address of the manufacturer, specialist dealer supplying the product

This product was manufactured by:



Schuchmann GmbH & Co. KG

Dütestraße 3 · 49205 Hasbergen

Tel. +49 (0)5405/909-0 · Fax +49 (0)5405/909-109

info@schuchmann.de · www.schuchmann.de

This product has been delivered by the following specialist dealer:

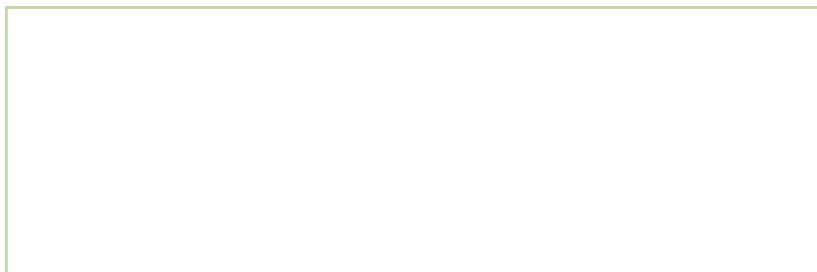



schuchmann.de